



**AAO instrumentation program and  
collaboration with China**

Jon Lawrence (AAO)



# AAO

- Australian Astronomical Observatory (AAO) was founded in 1974 to support the 3.9 m Anglo-Australian Telescope (AAT) in Siding Spring Observatory, Coonabarabran
- Now a Division of the Australia government Dept. of Innovation, Industry and Science
- Approx 90 staff split between Astronomy, Operations, Technology, and Corporate at two sites: Siding Spring Observatory and North Ryde, Sydney
- AAO Technology division includes the Instrument Science Group (12 postdocs) and the Instrumentation Group (25 managers and engineers)





## AAO Future

- Australian Astronomical Observatory (AAO) was founded in 1974 to support the 3.9 m Anglo-Australian Telescope (AAT) in Siding Spring Observatory, Coonabarabran
- Now a Division of the Australia government Dept. of Innovation, Industry and Science
- Approx 90 staff split between Astronomy, Operations, Technology, and Corporate at two sites: Siding Spring Observatory and North Ryde, Sydney
- AAO Technology division includes the Instrument Science Group (12 postdocs) and the Instrumentation Group (25 managers and engineers)
- In the ~12 months AAO will shift out of the Department into the Research sector:
  - AAO Telescope operations: run at SSO by a consortium of Universities led by ANU
  - AAO Technology: run at a Sydney location (TBD) by TBD (likely a consortium of Universities)



# AAO Instrument Projects: Past

Over 40 delivered instruments and 30 design studies

## Positioning systems

- FMOS/Echidna - fibre positioning robot for Subaru – 2007
- OzPoz - fibre positioning robot for the VLT – 2003
- 6dF - 150-fibre positioning robot for the UKST – 2001
- 2df - 2 degree field corrector and 400 fibre positioner for the AAT – 1997

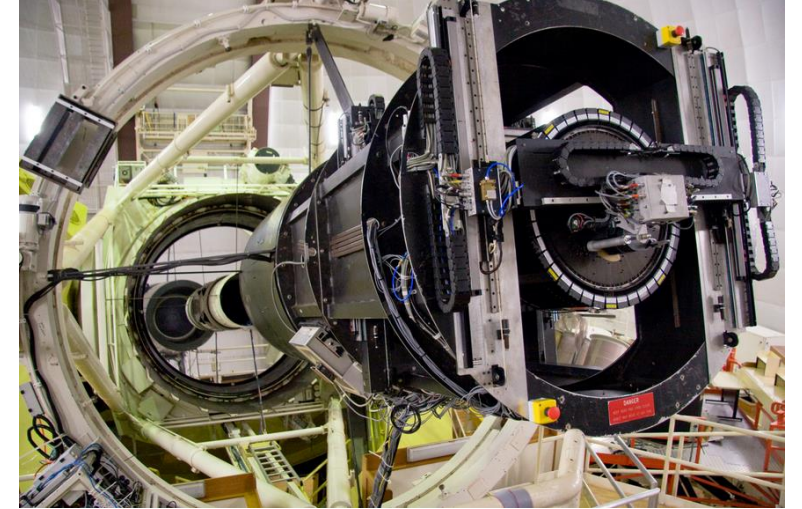

## Spectrographs

- HERMES - moderate resolution optical spectrograph for the AAT – 2014
- AAOmega - optical multi-object spectrograph for the AAT – 2006
- IRIS2 - near-infrared slit-mask spectrograph and imager for the AAT – 2002

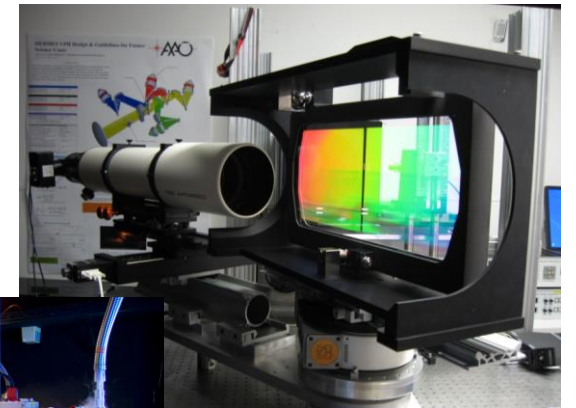

## Fibre Systems

- KOALA - 1000 element fibre-IFU for the AAT – 2014
- SAMI - multi-IFU hexabundle fibre feed for the AAT – 2013
- CYCLOPS2 - fibre image slicer for UCLES at the AAT – 2012

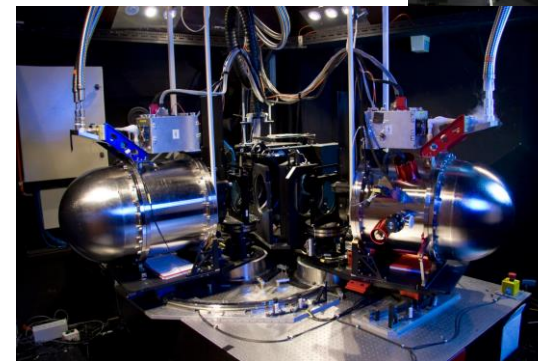





## AAO Instrument Projects: Current

### International Projects

- MANIFEST @ GMT
- 4MOST @ VISTA
- GHOST @ Gemini
- AST3-NIR @ Dome A
- PLATO @ Antarctica
- PRAXIS @ AAT
- Sphinx @ MSE
- NBS @ Subaru

### National Projects

- TAIPAN @ UKST
- Hector 1 @ AAT
- Veloce-Rosso @ AAT
- Huntsman @ SSO

### AAT Facility Upgrades

- 2DFDR @ AAT
- 2df upgrade @ AAT
- HERMES upgrade @ AAT
- Flat-field @ AAT

### Research and Development

- Positioning technologies
- Ring resonators
- K band fibres
- Detector controllers/cryostats
- Single-mode spectrographs
- Photonic interferometry
- Orbital Angular momentum
- Multi-core FBG for OH suppression
- Adaptive optics WFS and modes



## TAIPAN: Instrument



- TAIPAN is a fiber positioner and spectrograph being developed for the UK Schmidt Telescope
- Positioner is based on Starbugs technology, developed as a prototype for MANIFEST on GMT
- 150 fibres (upgrade to 300) over 6 degree FOV feeding a low resolution optical spectrograph
- Commenced mid-2013, due for science late 2017
- Will survey  $1e6$  galaxies and  $1e6$  stars for range of science cases

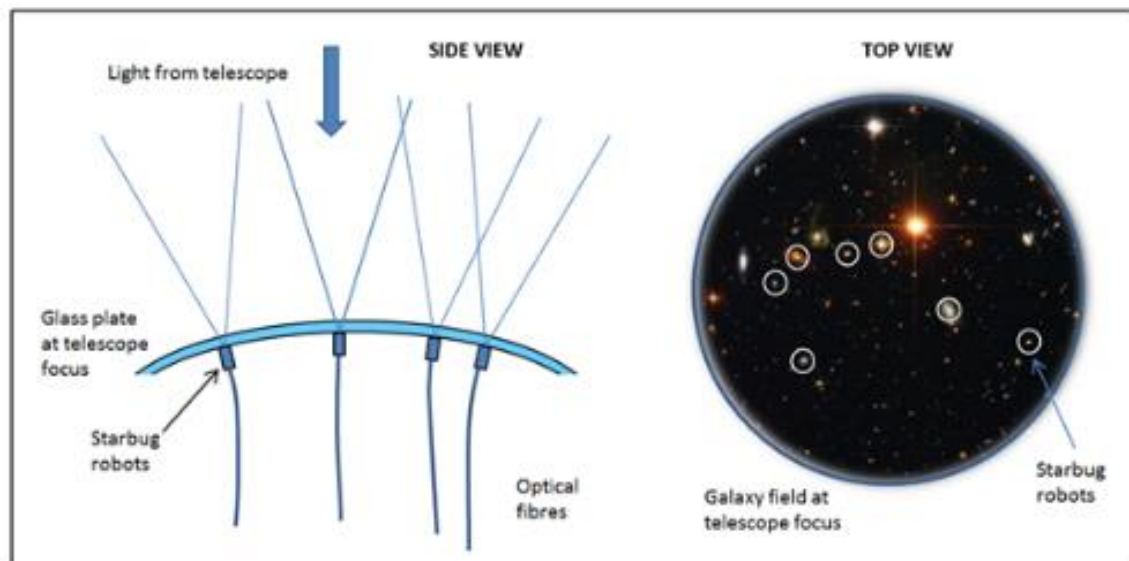



# TAIPAN: Positioner

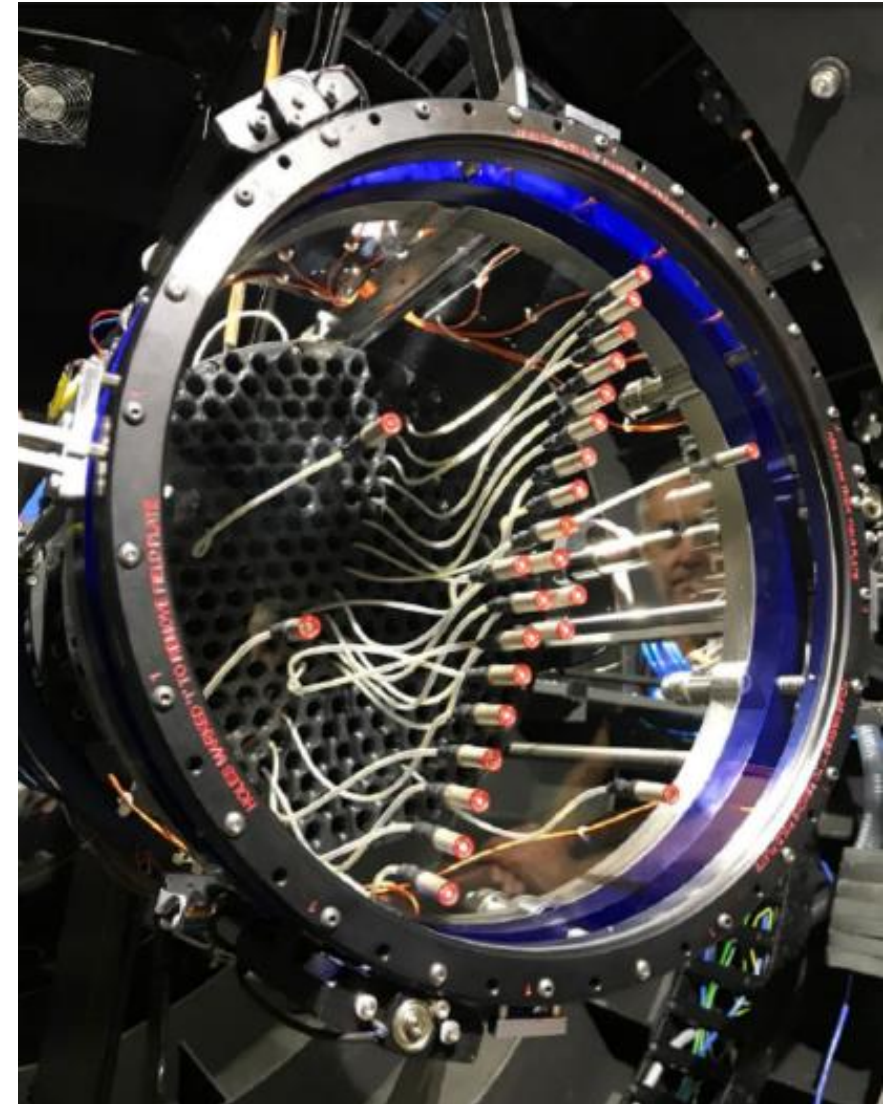
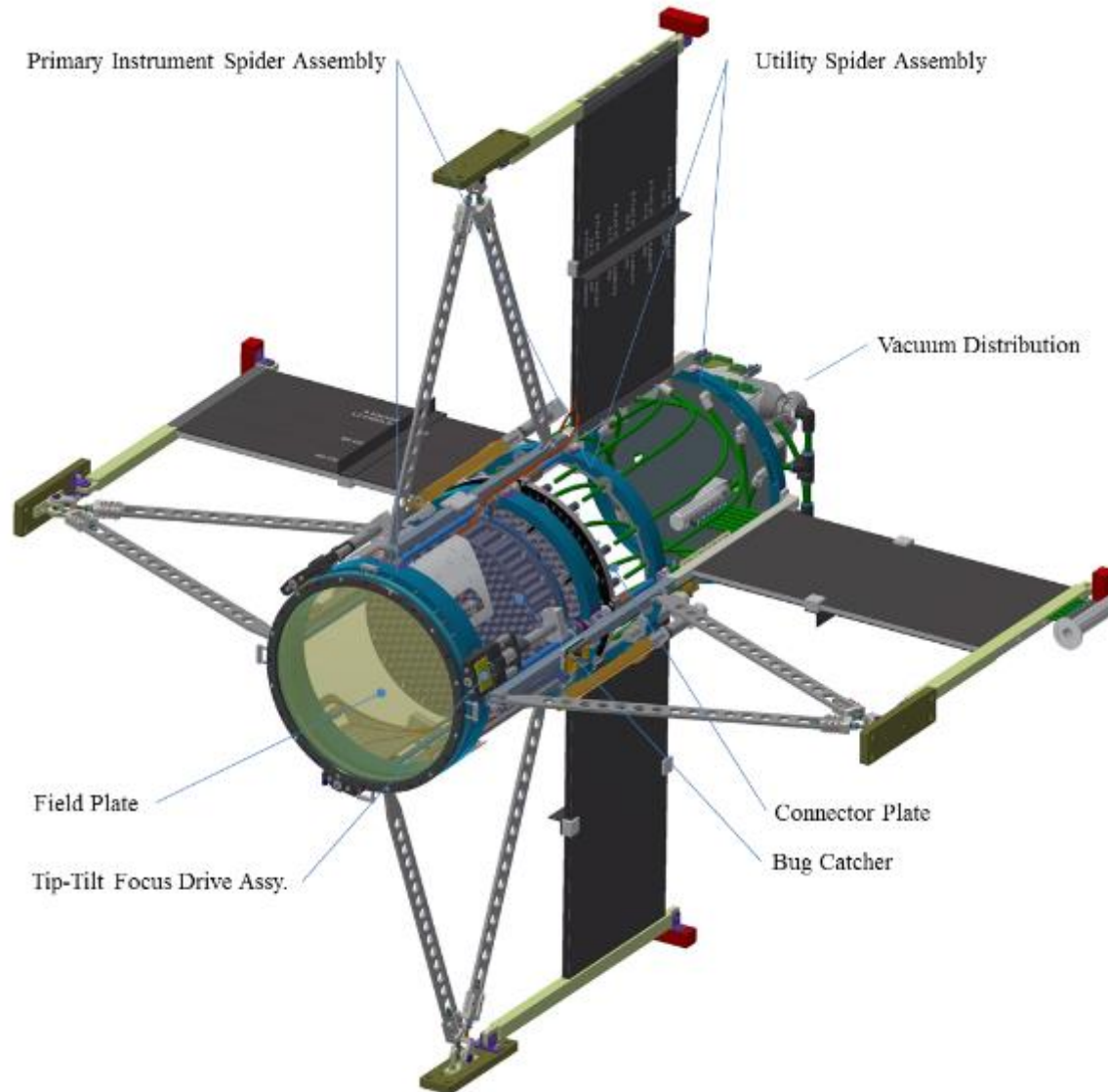





# TAIPAN: Spectrograph

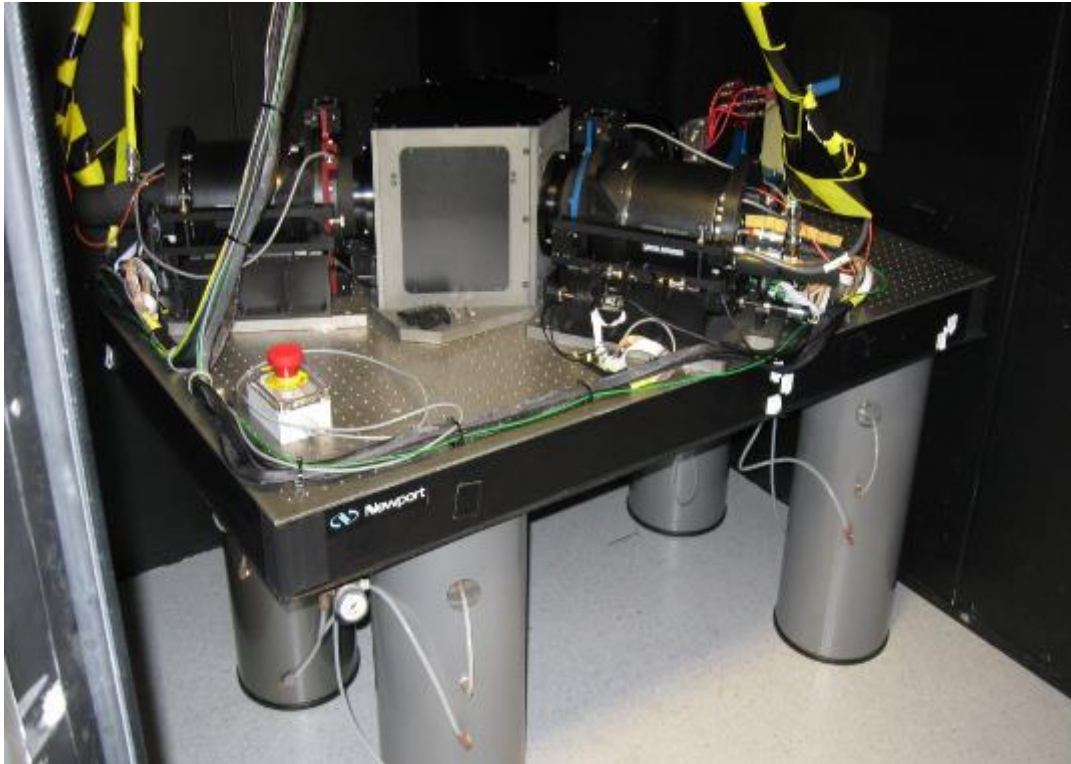

- Wavelength range: 370-870 nm
- 150 fibres fed at f/2.5
- Refractive design
- Max 100 mm beam
- 5 lens collimator, 5 lens cameras
- Total of 8 aspheric surfaces in design with 4 distinct lenses

- 2 arms using 2kx2k E2V
- COTS cooler/controller
- R=2300

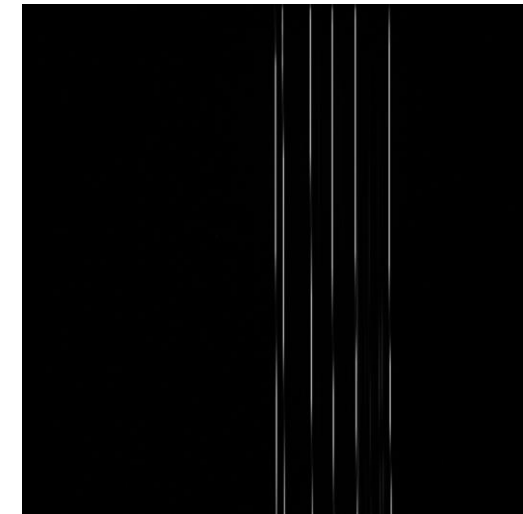
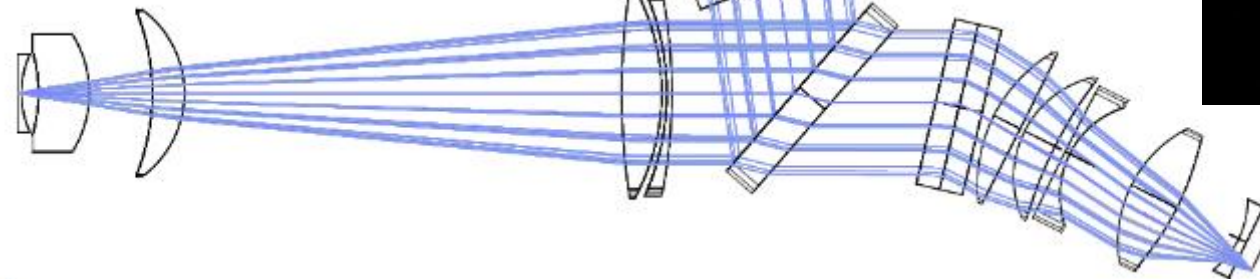





# MANIFEST: Instrument

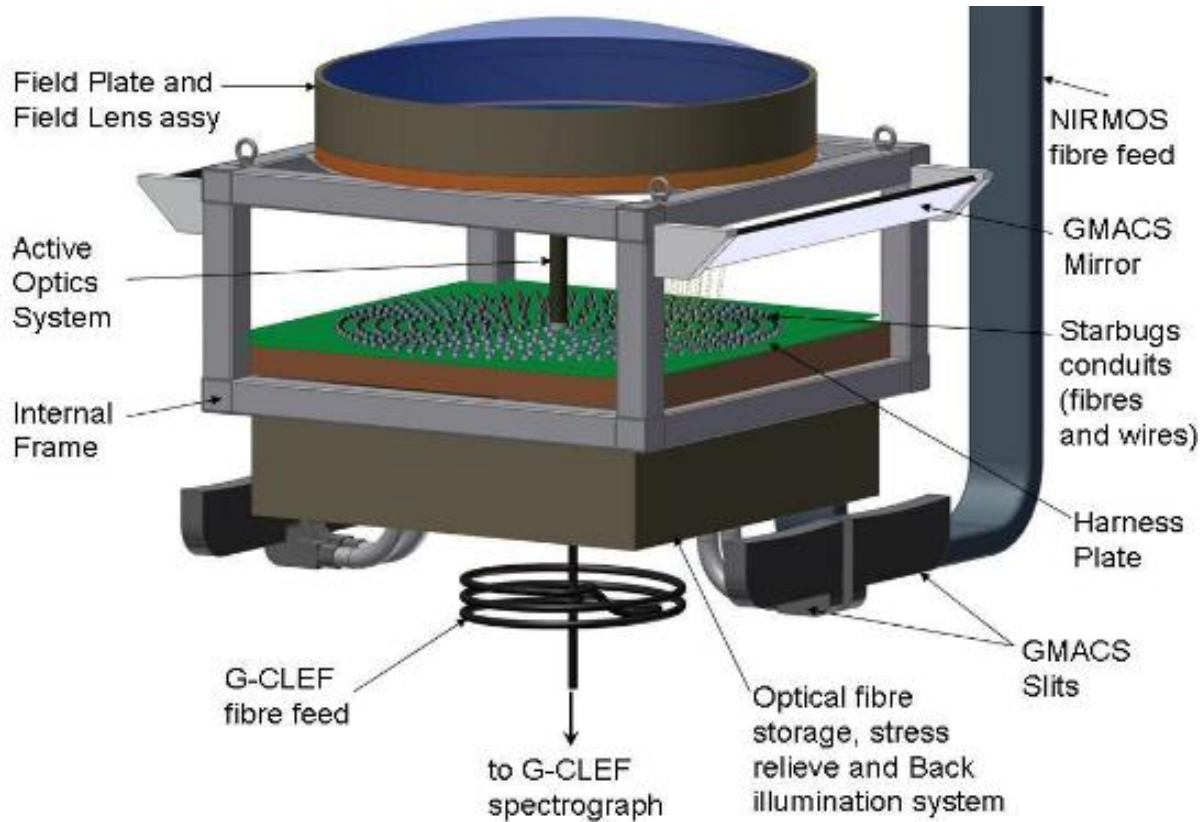

- GMACS (Texas A&M): low resolution optical spectrograph
- G-CLEF (Harvard): high resolution white pupil Echelle spectrograph

	TAIPAN	MANIFEST
Number of Starbugs	150-300	>2000
Field of View	6 degrees	20 arcmins
Field ROC	3 m	3.3 m
Field diameter	330 mm	1250 mm
Pitch	~12 mm	~50 mm
Payload	Single fibre	IFU

- MANIFEST is extension of TAIPAN for Giant Magellan Telescope
- Feeds GMACS and G-CLEF instruments
- Provides high res, wide FOV, high multiplex
- Interface Study will commence in 2017



# MANIFEST: modes

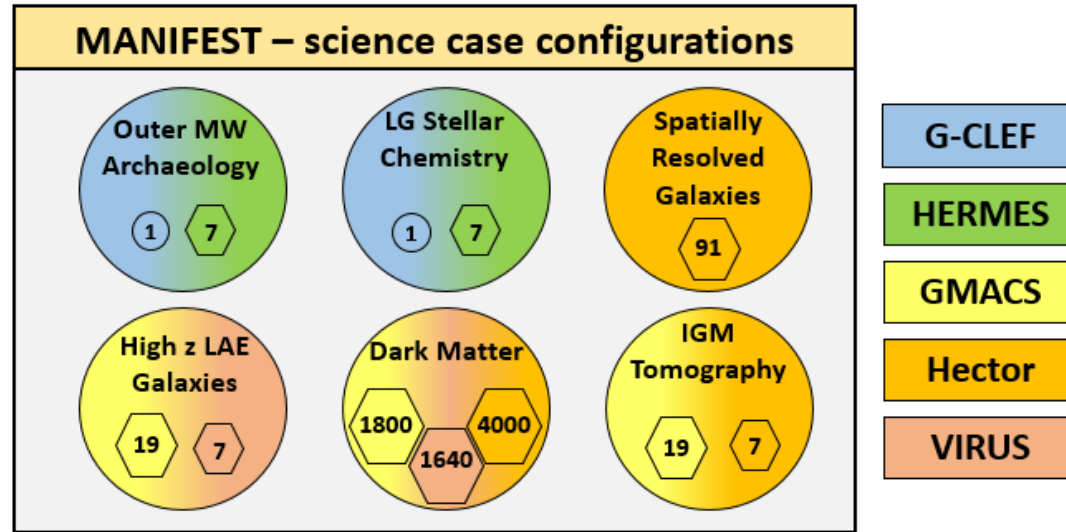

Spectrograph	# IFUs	Fibres per IFU	FOV per IFU	Resolution	Bandwidth
G-CLEF	4/40	1	0.7"	35K	550/15 nm
HERMES	56	7	1"	28K	100 nm
GMACS	60	61	1.1"	6K/20K	600/200 nm
GMACS	95	19	1.25"	3K/10K	600/200 nm
Hector	44	91	2.8"	5K	680 nm
Hector	560	7	0.75"	5K	680 nm
VIRUS	1	1640	14"	2K	630 nm
VIRUS	235	7	0.9"	2K	630 nm



# AESOP for 4MOST for VISTA

- 4MOST is a MOS for ESO Vesta telescope: AIP leading, AAO supplying AESOP positioner
- AESOP 2400 fibre spines using piezo actuators (based from Echidna at Subaru)
- Fibres feed bank of 3 optical spectrographs:
  - 2 x low res ( $R=4000-8000$  with 370-950 nm)
  - 1 x high res ( $R=20,000$  with 400-680 nm with gaps)
- Science: cosmology, galaxy evolution, high-energy and Galactic science; complement to space (Gaia, Euclid) and ground (VISTA, VST, LSST)

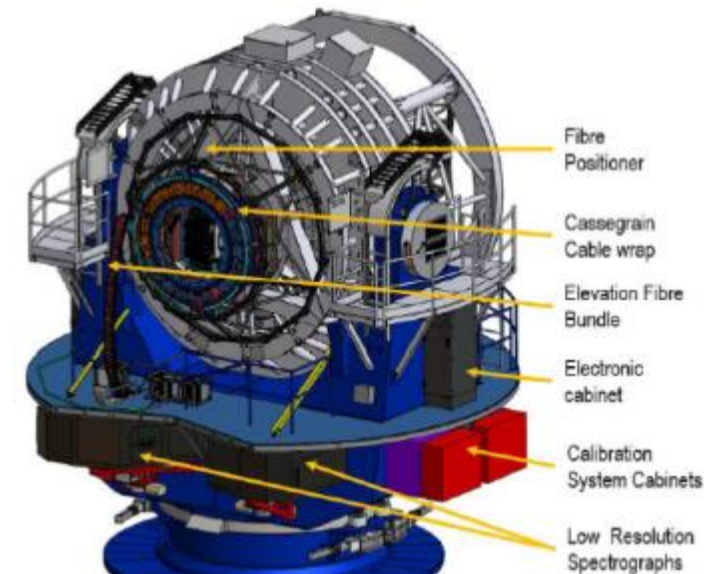
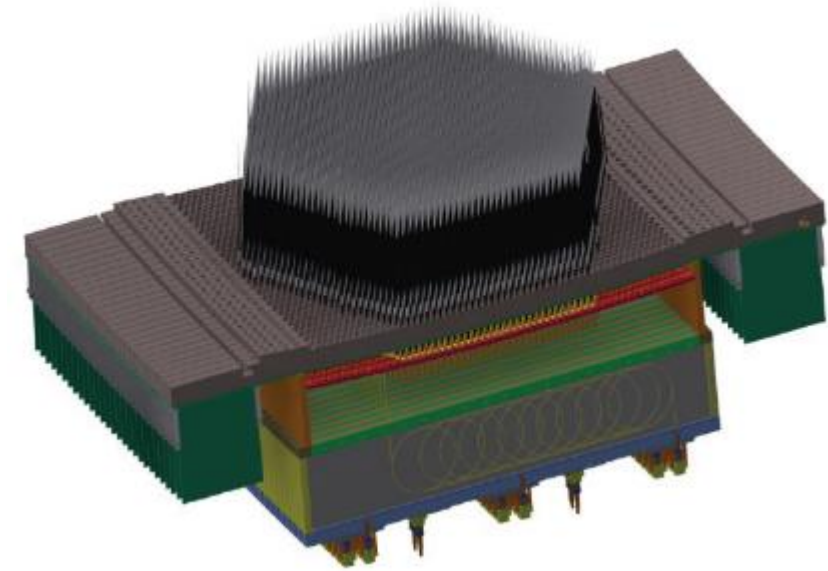





# Hector: Concept

- **SAMI**: 13 x 61 element hexabundles (819 fibres) using triplet 1 degree FOV feeding AAOmega (flexible) spectrograph at the AAT → **targeting 3000 galaxies**

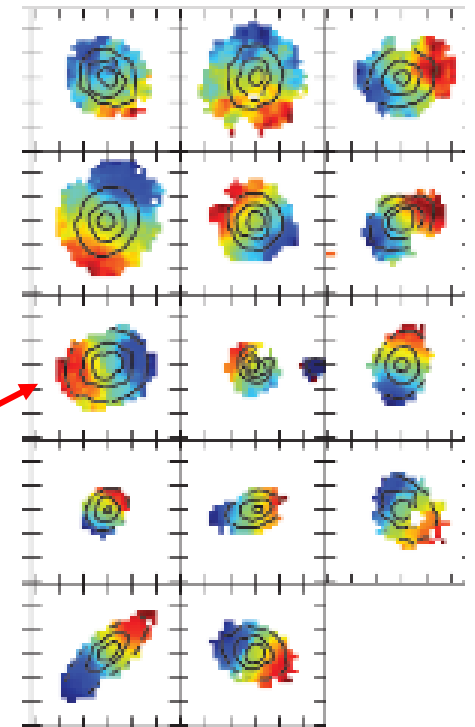
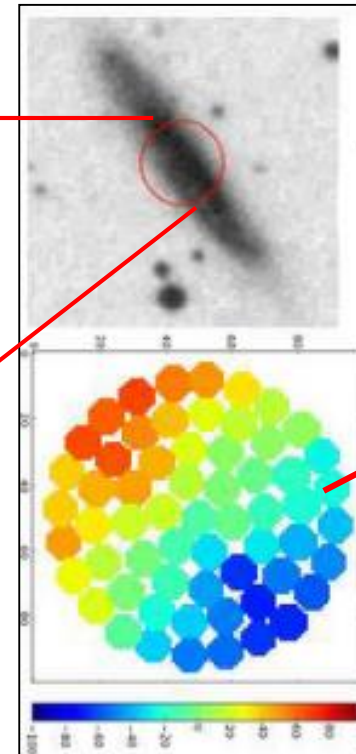
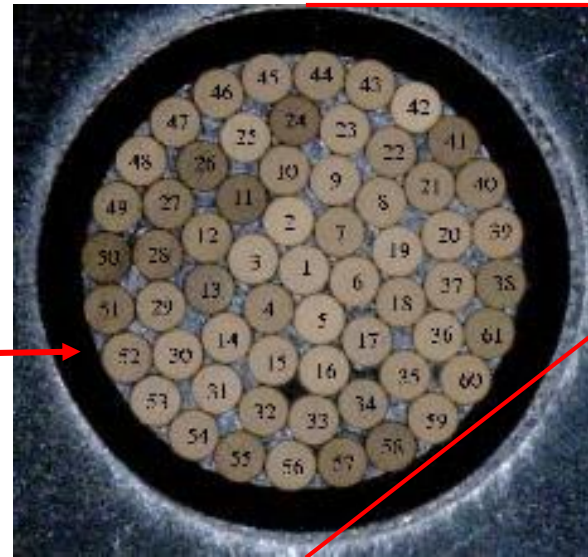
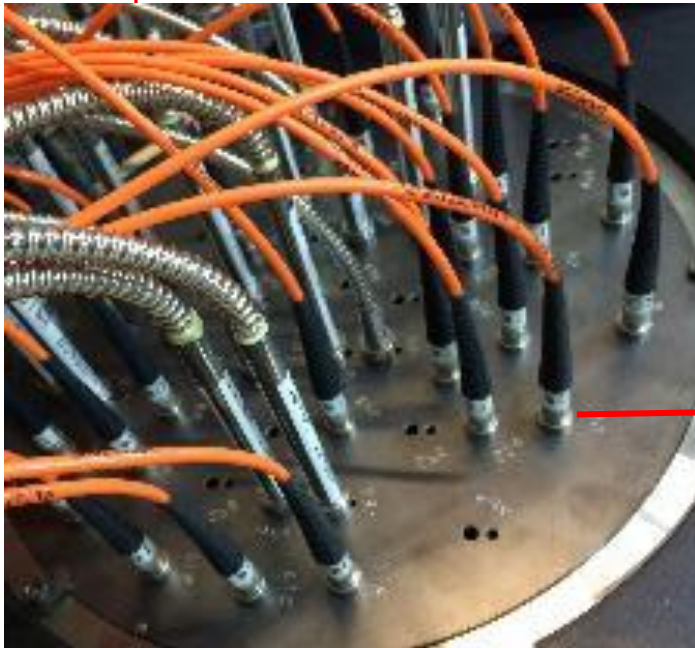

- **Hector 3df** : >100 x 100 element hexabundles (10,000 fibres) using new 3df corrector feeding dedicated fixed format spectrographs at the AAT → **targeting 100,000 galaxies**



## Hector: Instrument

- Large trade-off space for spectrograph, currently narrowing down
- $R=5000-7000$  fixed format
- Wavelength 370-780 nm (goal to 1000nm)
- 1000 fibres/spectrograph (4kx4k)
- 2 (goal 3) arms
- One spectrograph being built for Phase 1
- Up to 7 spectrographs for full Hector

- Stellar kinematics: assembly history from high order kinematics, environment and morphology, build up of mass and angular momentum, stellar-mass/velocity scaling relations
- Emission line science: winds/outflows, AGN-SF separation, metallicity, stellar/gas kinematics
- Dark matter: improved weak lensing shear measurements

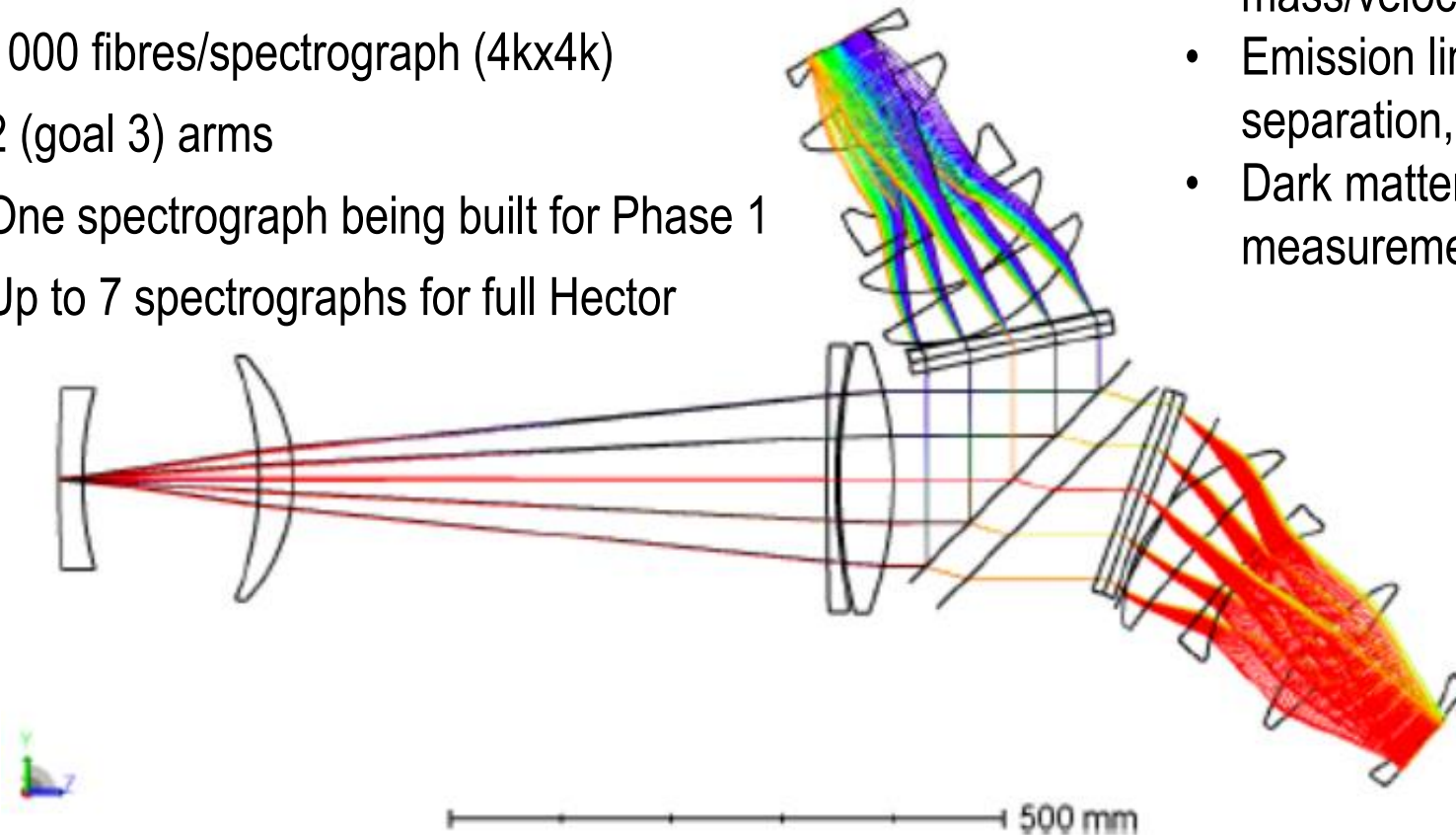



# GHOST for Gemini

- GHOST for Gemini telescope: AAO lead and positioner, NRC spectrograph, ANU software
- Stellar abundance, metal poor stars, globular clusters, dwarf galaxies, exoplanets...
- $R=50,000$  (two object),  $R=75,000$  (1 object)
- Wavelength 360-1000nm
- White pupil Echelle design with 2 arms
- Uses fibre image slicer
- Now in build phase with commissioning early 2019

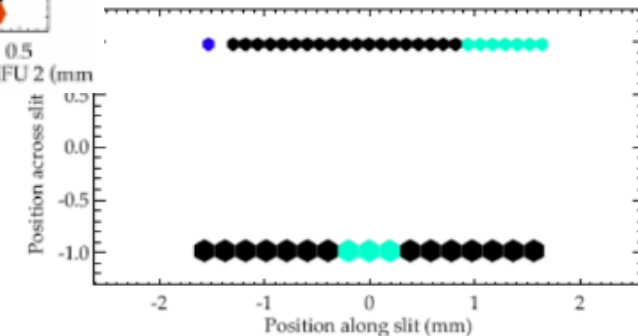
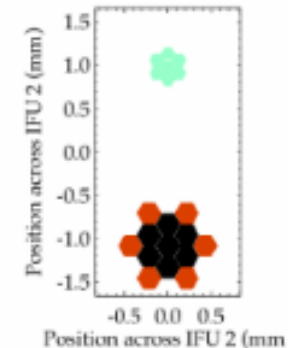
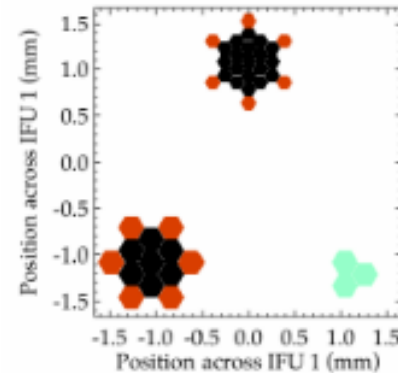
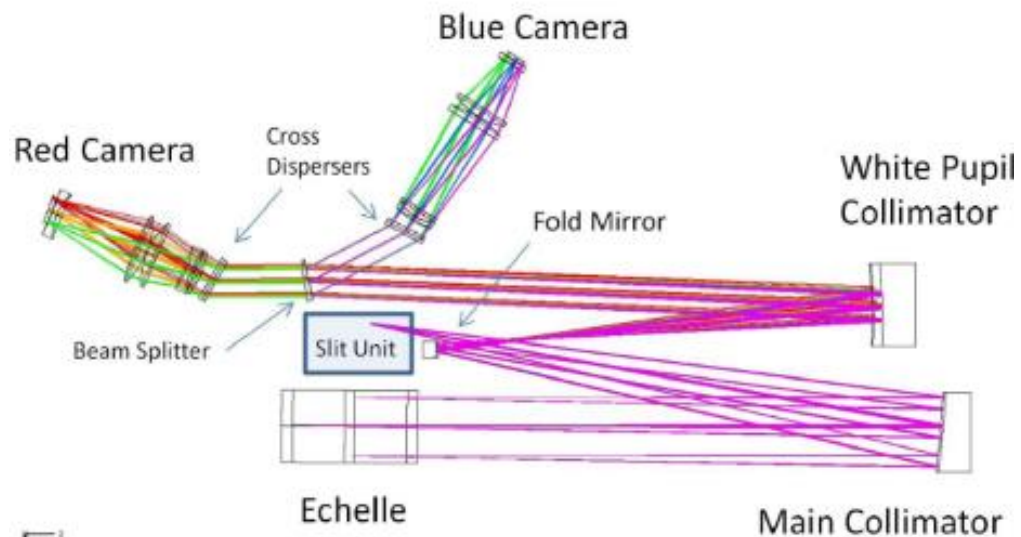
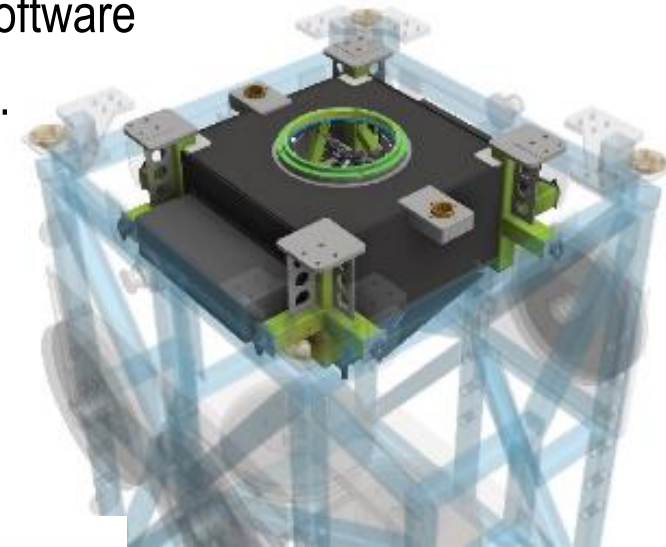





## AST3-NIR: Project

- Collaboration: AAO, UNSW, Usyd, ANU, NAIOT, PMO, TAMU, CalTech
- Deploy wide field infrared (Kdark) camera to Dome A, Antarctica
- Low infrared sky background
- Telescope supplied by NAIOT, camera by AAO
- Step towards larger scale Antarctic facilities (eg KDUST)

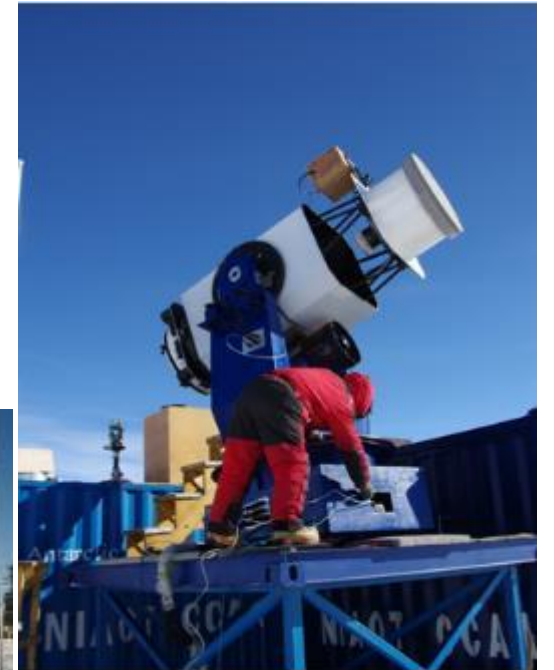
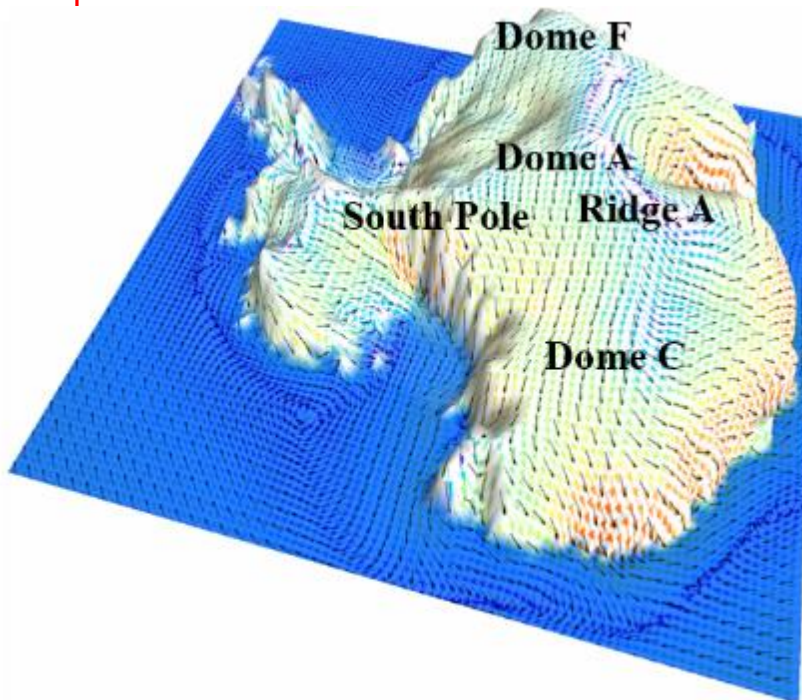



## AST3-NIR: Instrument

- Wavelength range: Kdark window (nominally  $\lambda=2.36 \mu\text{m}$  with  $\Delta\lambda=0.18 \mu\text{m}$ ) only
- Primary mirror diameter: 680 mm
- Detector Array: mosaic of 2 x 2kx1k near infrared MCT array from Leonardo (UK)
- Spatial sampling/FOV: 1.4" per pixel gives up to 45' x 45'
- Detector has now been ordered!

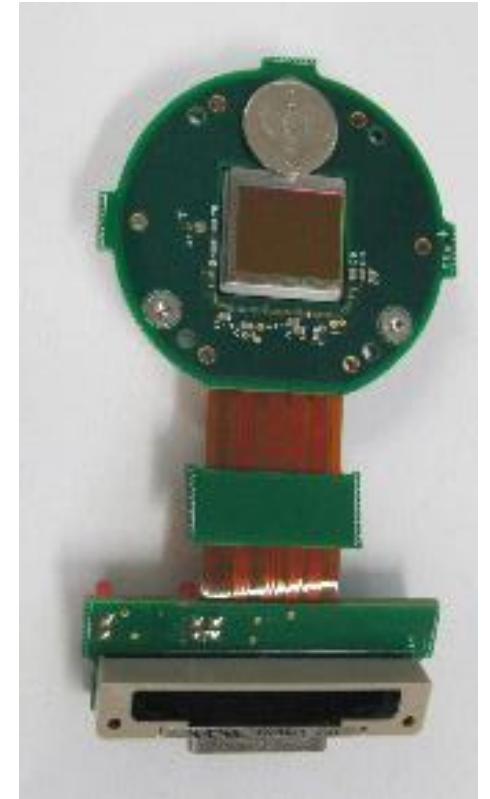
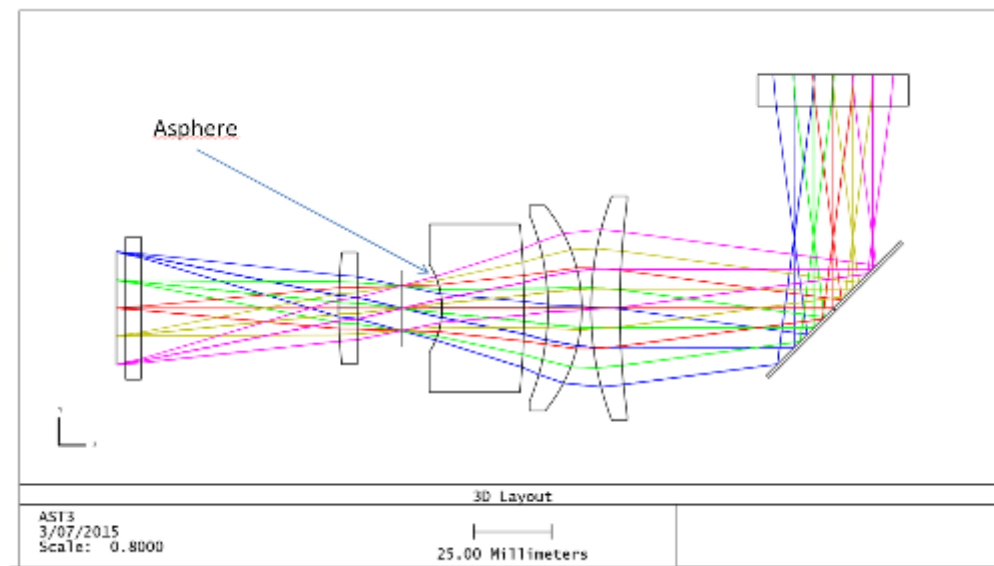
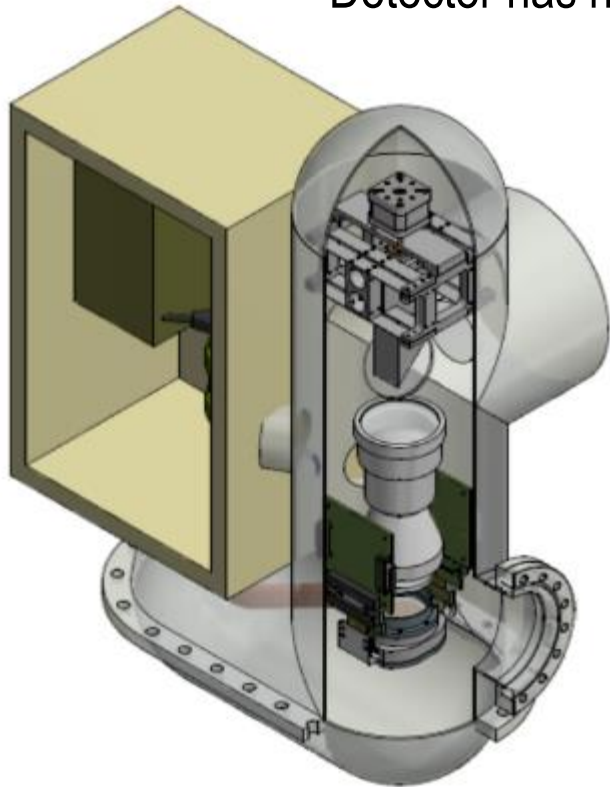



# Veloce

- Veloce for AAT: UNSW lead, ANU spectrograph, AAO fibre cable and interface
- $R=80,000$  (single object plus sky)
- Wavelength 600-950nm with upgrade to include 2 extra arms (down to 370nm)
- Simultaneous wavelength calibration with Menlo system laser comb
- White pupil Echelle design
- Radial velocity precision of 0.5m/s (temperature and pressure stabilised)
- Uses fibre image slicer
- Science: obtain Doppler velocities for Sun-like and M-dwarf stars, TESS exoplanet follow-up, HERMES/Gaia follow-up

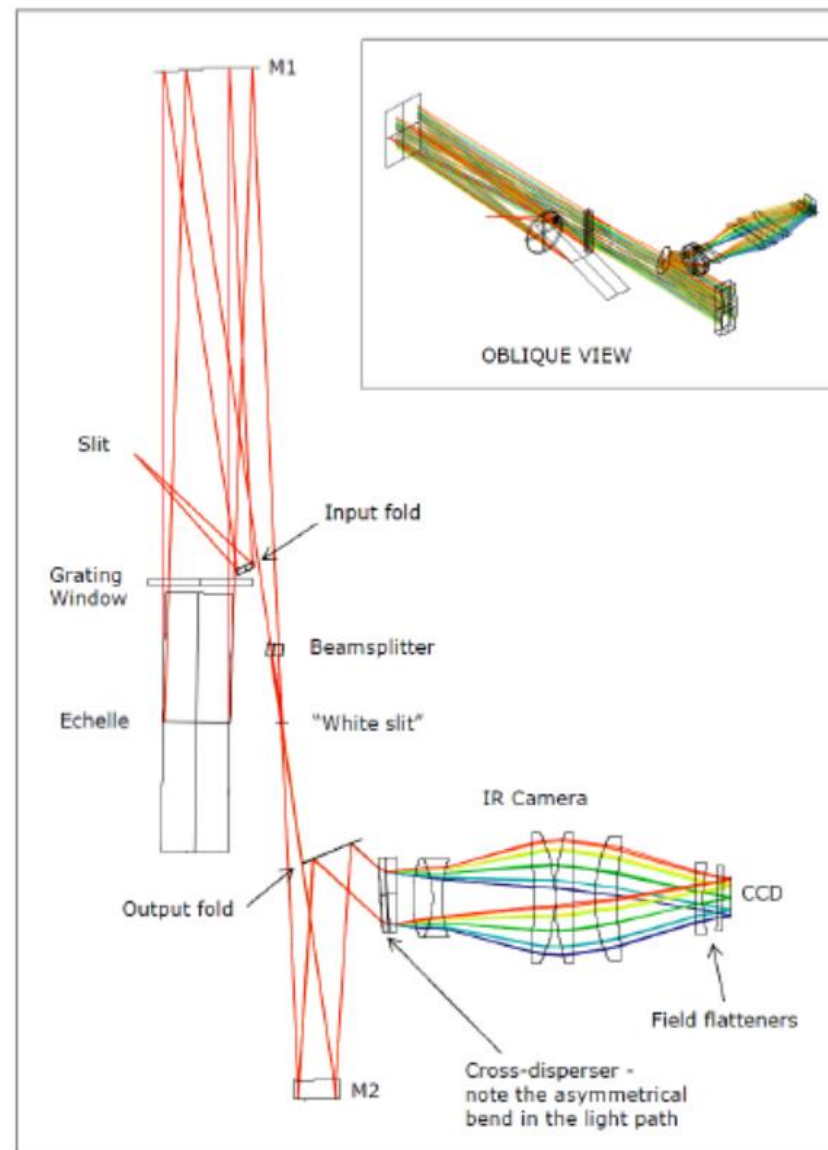





# PRAXIS

- GNOSIS used Fibre Bragg gratings and photonic lanterns to filter out the OH lines.
- OH lines suppressed but did not reach the expected interline continuum.
- PRAXIS is new dedicated spectrograph (AAO) with H2RG detector (AIP)
- Parallel development of FBG in multi-core fibres (USyd)
- PRAXIS due on-telescope at AAT early 2018

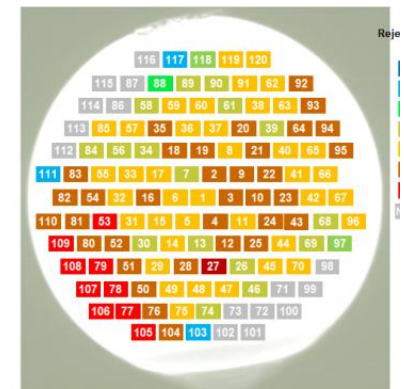
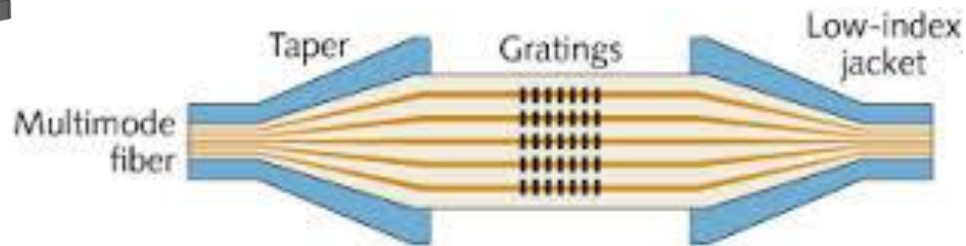
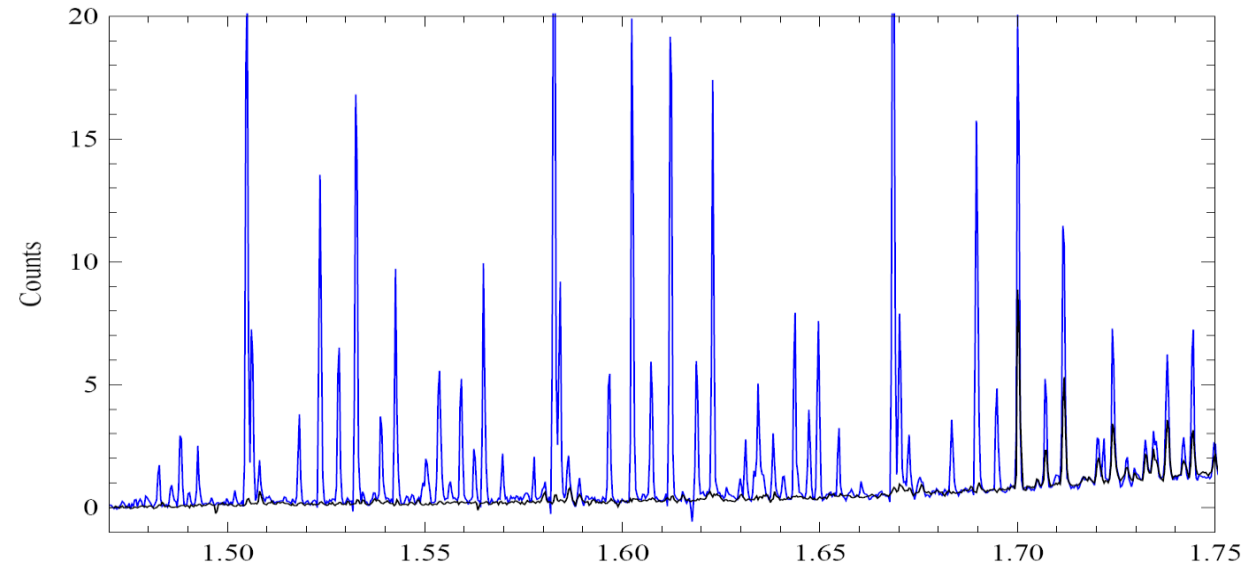
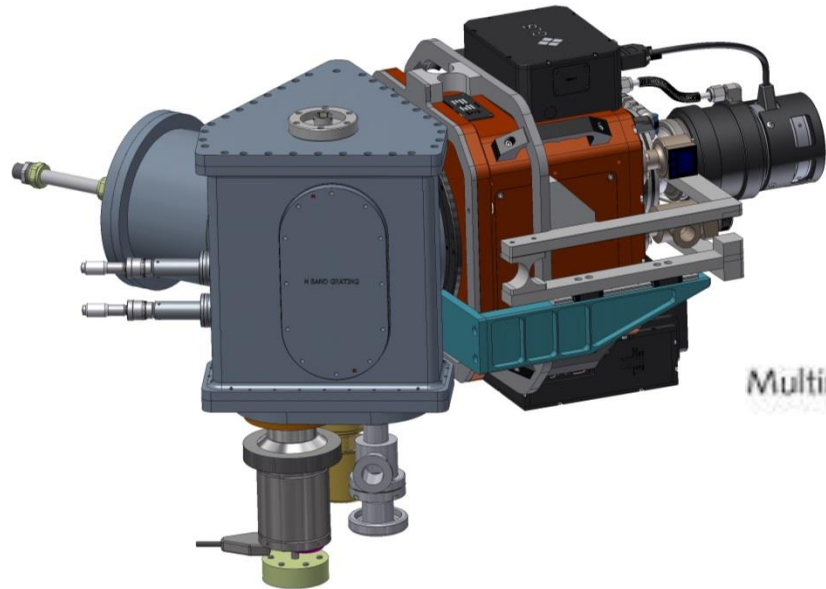



## **Future projects and collaboration with China**



## KDUST: Concept

- 2.5 telescope proposed by China for Dome A.
- Legacy from PILOT (Australia-led proposal for Dome C).
- Australia potential contributions to the instrument design, science and observatory.

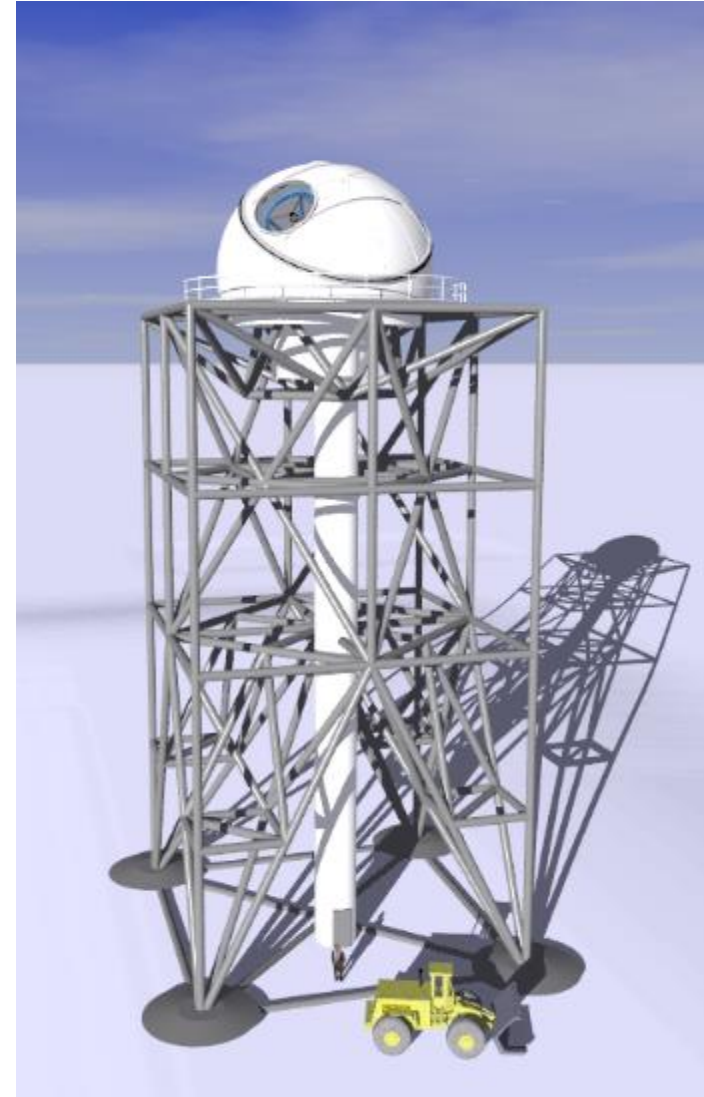
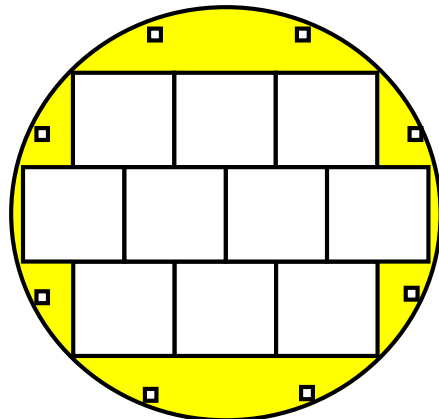
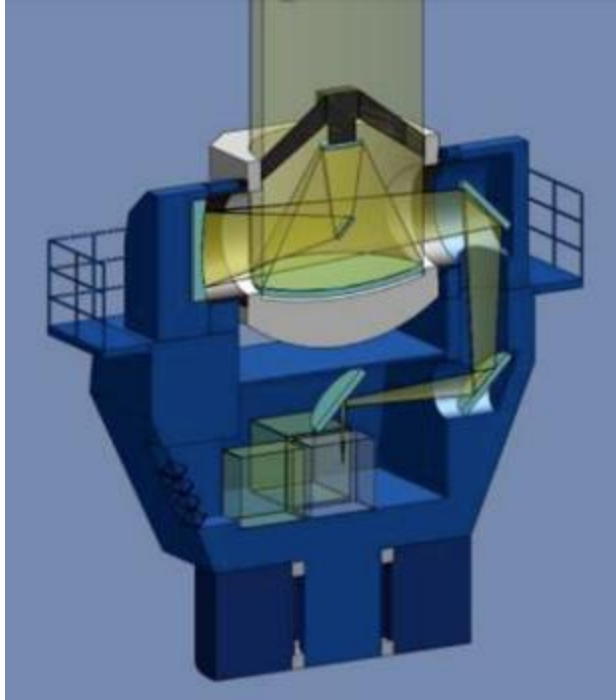





# LOT: concept

- LOT is 12 m proposed in China
- Location TBD within China
- Will have a broad suite of instruments
- Australia potential contributions to a range of instrument options, also science and observatory

## 望远镜结构

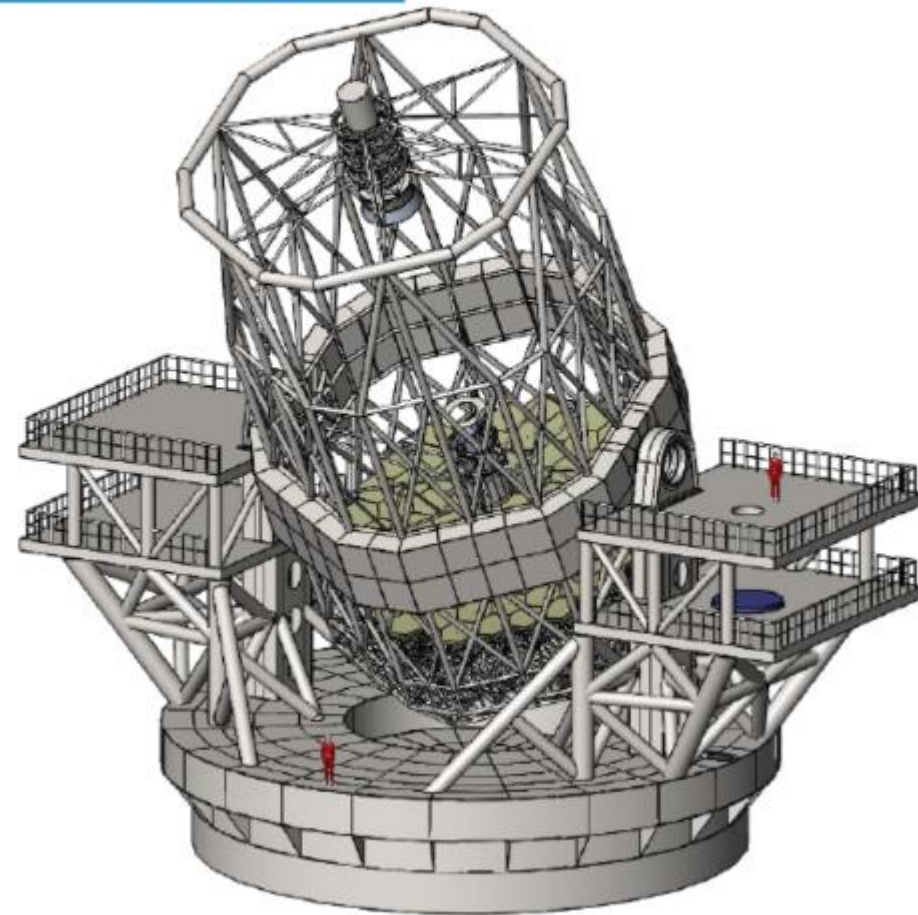

Instruments	Wavelength coverage (nm)	Focus	FOV	Spectral Resolution	Note
WFIS	410-1050	Nasmyth	14'x4'	1000-5,000	Seeing-limited
HRS	370-930	Coude	20"	30,000-50,000/ 100,000-160,000	Seeing limited
BMRS	320-1500	Nasmyth	1.5'x1.5'	2,000-10,000	Seeing limited
Exoplanet imager	840-2,400	Nasmyth	2" x2"	Diffraction @H Band	Ex AO



## ANU – RSAA – AITC



- The Advanced Instrumentation and Technology Centre at ANU have overlapping and complimentary skills and expertise
- Successful history of collaborating with the AAO



## Summary

- AAO have a wide portfolio of astronomy instrumentation projects providing example of unique expertise
- Already an MoU in place between AAO/AITC/NIAOT to
  - Provide technical and scientific expertise
  - To jointly develop instrument concepts for LOT and KDUST
- Future projects:
  - potential for joint or consortium bids for other telescopes?
  - Chinese contribution to Australian telescopes and projects?